

STEELBOX

STEEL&STYLE

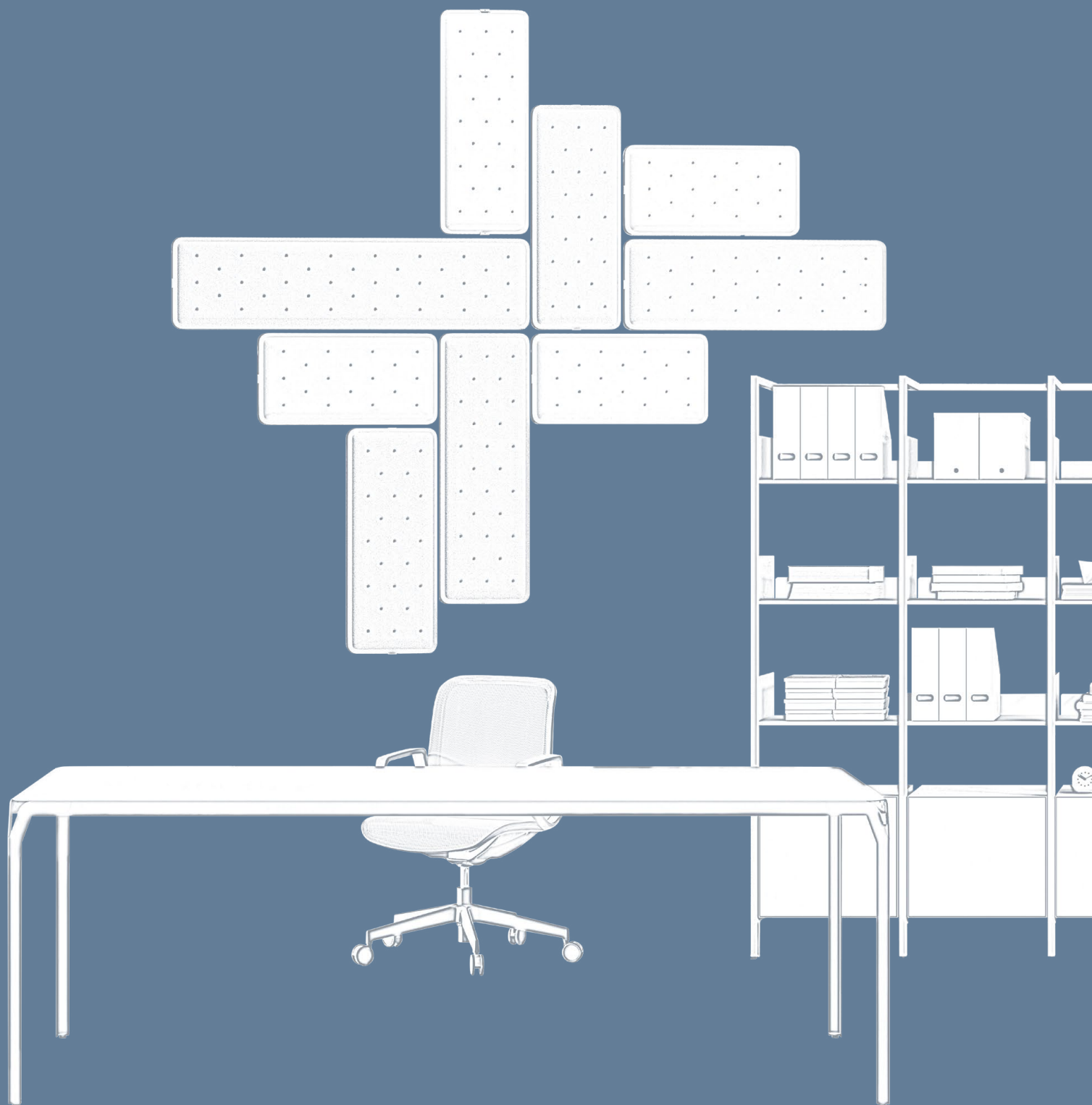

TECHNICAL BOOK

Mikai



Scopri la **libreria a muro Mikai**, un'elegante innovazione nel mondo dell'arredamento, progettata per coniugare stile, praticità e versatilità. Mikai si distingue dalle altre librerie sul mercato grazie a un design raffinato e alla facilità di montaggio.

Una delle caratteristiche distintive di Mikai è la sua struttura invisibile: gli slot di aggancio dei ripiani non sono visibili all'esterno, conferendo alla libreria un aspetto pulito e minimalista. Questo non solo accentua la sua estetica moderna, ma elimina anche il fastidioso visivo di elementi di fissaggio evidenti, garantendo un design elegante.

La versatilità di Mikai è un tratto che la rende straordinariamente poliedrica. Con due dimensioni disponibili, questa libreria si adatta facilmente a diverse esigenze di spazio. Inoltre, grazie all'innovativo utilizzo di due staffe, Mikai offre la possibilità di ospitare i contenitori MBox, fornendo uno spazio di archiviazione intelligente e integrato direttamente nella struttura.

Ma le sorprese non finiscono qui. Mikai è progettata per offrire un'esperienza d'uso ancora più completa. Con l'aggiunta di un top in legno, la libreria può trasformarsi in una pratica scrivania anche per l'home office, aggiungendo un elemento multifunzionale all'arredamento del tuo spazio. Questa opzione amplia ulteriormente le possibilità di utilizzo, rendendo Mikai ideale per ambienti sia domestici che professionali.

Il montaggio di Mikai è una procedura intuitiva e senza sforzo. Con Mikai, non solo investi in una libreria dal design moderno e pulito, ma ti assicuri anche una soluzione di arredo flessibile e adattabile alle tue esigenze. Rinnova il tuo spazio con la libreria Mikai, dove la semplicità incontra l'eleganza e la funzionalità.

*Discover the **Mikai wall-mounted bookshelf**, an elegant innovation in the world of furniture, designed to blend style, practicality, and versatility seamlessly. Mikai stands out from other bookshelves on the market with its refined design and ease of assembly.*

One of Mikai's distinctive features is its invisible structure: the shelf attachment slots are not visible externally, giving the bookshelf a clean and minimalist appearance. This not only enhances its modern aesthetics but also eliminates the visual discomfort of prominent fastening elements, ensuring an elegant design.

Mikai's versatility is a standout feature, making it exceptionally multifaceted. With two available sizes, this bookshelf easily adapts to various space requirements. Furthermore, thanks to the innovative use of two brackets, Mikai offers the possibility to accommodate MBox containers, providing smart storage space integrated directly into the structure.

But the surprises don't end there. Mikai is designed to offer an even more comprehensive user experience. With the addition of a wooden top, the bookshelf can transform into a practical desk for home office, adding a multifunctional element to your space's decor. This option further expands the possibilities of use, making Mikai ideal for both home and professional environments.

The assembly of Mikai is an intuitive and effortless process.

■ La libreria Mikai ha una struttura essenziale, che si appoggia al muro, lasciando uno spazio tra i ripiani ed il muro stesso. In una misura di altezza e due di larghezza i ripiani sono discretamente agganciati lungo i montanti, sapientemente nascosti per evitare di mostrare la cremagliera. I ripiani possono essere sostituiti da un piano di lavoro, per trasformare la libreria in Home Office e con dei contenitori Mbox per accrescerne lo spazio storage.

Mikai bookcase has an essential structure, which leans against the wall, leaving a space between the shelves and the wall itself. In one measure in height and two in width, the shelves are discreetly hooked along the uprights, cleverly hidden to avoid showing the rack. The shelves can be replaced by a worktop, to transform the library into a Home Office and with Mbox containers to increase the storage space.

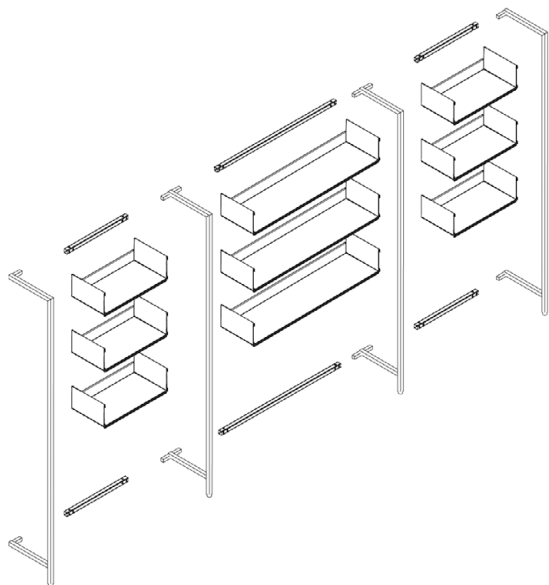

■ La libreria Mikai diventa anche contenimento con moduli metallici, aperti, chiusi o con cassetti per ampliare la capacità di storage in combinazione con la serie MBOX. Mikai bookcase also becomes a containment with metal storage, open, closed or with drawers to expand storage capacity in combination with MBOX range.

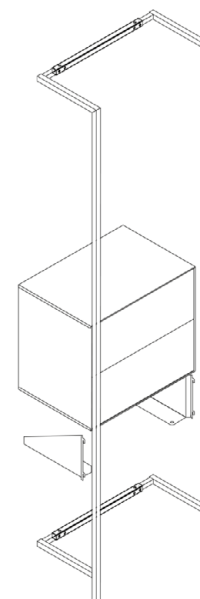

Mikai

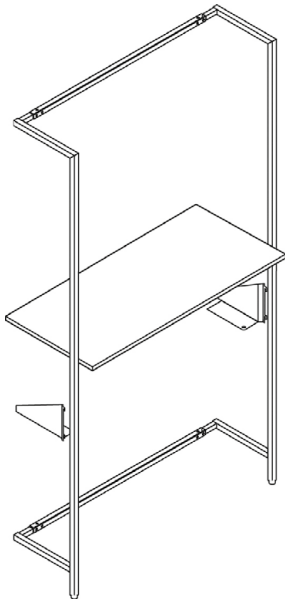
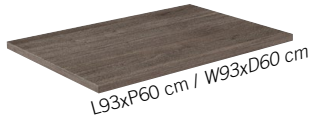

Con l'aggiunta di un semplice piano di lavoro, Mikai si trasforma in un comodo scrittoio per lo smart working o lo studio.
Just adding a simple desktop Mikai become a handy studio desk for remote working or simple homeworking.





Per completare MIKAI libreria con MBOX, vedi pagina 78
To complete Mikai bookcase with Mbox, check page 78

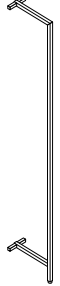
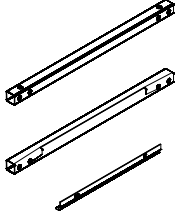
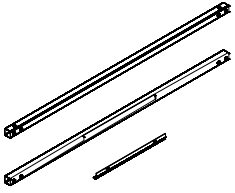

MIKAI

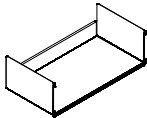
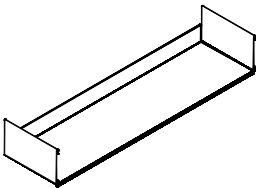
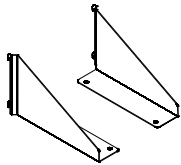
DESCRIZIONE <i>description</i>	CODICE <i>code</i>	KG	M ³	COLLI <i>pcs</i>		CODICE FINITURA (*) <i>finish code (*)</i>																																	
MIKAI LIBRERIA FIANCO DESTRO cm P 35.5 x H 191.5 <i>Mikai bookshelf right side upright cm D 35.5 x H 191.5</i> 	MIKFDX00****	3,60	0,020	1,00		<table border="1"> <thead> <tr> <th colspan="3">COLORI METALLO / METAL COLORS</th> </tr> <tr> <th>(*)</th> <th>colore</th> <th>colour</th> </tr> </thead> <tbody> <tr> <td>4002</td> <td>bianco</td> <td>white</td> </tr> <tr> <td>5000</td> <td>nero matt</td> <td>matt black</td> </tr> <tr> <td>2008</td> <td>avio</td> <td>misty blue</td> </tr> <tr> <td>3900</td> <td>rosso granata</td> <td>granata red</td> </tr> <tr> <td>2006</td> <td>verde salvia</td> <td>sage green</td> </tr> <tr> <td>2004</td> <td>cipria</td> <td>dusty pink</td> </tr> <tr> <td>2003</td> <td>caffè</td> <td>coffee</td> </tr> <tr> <td>7016</td> <td>antracite</td> <td>anthracite</td> </tr> <tr> <td>7035</td> <td>grigio</td> <td>light grey</td> </tr> </tbody> </table>	COLORI METALLO / METAL COLORS			(*)	colore	colour	4002	bianco	white	5000	nero matt	matt black	2008	avio	misty blue	3900	rosso granata	granata red	2006	verde salvia	sage green	2004	cipria	dusty pink	2003	caffè	coffee	7016	antracite	anthracite	7035	grigio	light grey
	COLORI METALLO / METAL COLORS																																						
(*)	colore	colour																																					
4002	bianco	white																																					
5000	nero matt	matt black																																					
2008	avio	misty blue																																					
3900	rosso granata	granata red																																					
2006	verde salvia	sage green																																					
2004	cipria	dusty pink																																					
2003	caffè	coffee																																					
7016	antracite	anthracite																																					
7035	grigio	light grey																																					
MIKAI LIBRERIA FIANCO SINISTRO cm P 35.5 x H 191.5 <i>Mikai bookshelf left side upright cm D 35.5 x H 191.5</i> 	MIKFSX00****	3,60	0,020	1,00																																			
MIKAI LIBRERIA FIANCO CENTRALE cm P 35.5 x H 191.5 <i>Mikai bookshelf central side upright cm D 35.5 x H 191.5</i> 	MIKCEN00****	3,60	0,020	1,00																																			
MIKAI LIBRERIA KIT CONNETTORI FIANCHI cm L. 46 <i>Mikai bookshelf sides connector kit cm L. 46</i> 	MIKTRA46****	1,60	0,001	1,00																																			
MIKAI LIBRERIA KIT CONNETTORI FIANCHI cm L. 93 <i>Mikai bookshelf sides connector kit cm L. 93</i> 	MIKTRA93****	3,60	0,020	1,00																																			

MIKAI						
DESCRIZIONE <i>description</i>	CODICE <i>code</i>	KG	M ³	COLLI <i>pcs</i>		CODICE FINITURA (*) <i>finish code (*)</i>
MIKAI RIPIANO cm L 46 x P 25 <i>Mikai shelf cm W 46 x D 25</i> 	MIKRIP46****	4,00	0,025	1,00		
MIKAI RIPIANO cm L 93 x P 25 <i>Mikai shelf cm W 93 x D 25</i> 	MIKRIP93****	6,30	0,050	1,00		
SET 2 STAFFE PER IL MONTAGGIO DEL CONTENITORE MBOX E DEL MIKAI DESKTOP SU LIBRERIA MIKAI <i>Set of 2 brackets to mount mbox container and mikai desktop on mikai bookshelf</i> 	MBOXKITS****	1,50	0,025	1,00		
MIKAI DESKTOP cm L93 x P60 x sp1,8 <i>Mikai desktop cm W93 x D60 x thick.1,8</i> 	MIKP93****	12,00	0,030	1,00		
						COLORI METALLO / METAL COLORS
						(*)
						colore
						colour
						4002
						bianco
						white
						5000
						nero matt
						matt black
						2008
						avio
						misty blue
						3900
						rosso granata
						granata red
						2006
						verde salvia
						sage green
						2004
						cipria
						dusty pink
						2003
						caffè
						coffee
						7016
						antracite
						anthracite
						7035
						grigio
						light grey
						LEGNO / WOOD
						(*)
						colore
						colour
						0041
						avio
						misty blue
						0059
						nero
						black matt
						0046
						cipria
						dusty pink
						0003
						rovere
						oak
						0040
						verde salvia
						sage green
						0007
						noce classico
						classic walnut
						0013
						noce moderno
						modern walnut
						0068
						bianco
						white
						0039
						rosso granata
						granata red

DESCRIZIONI TECNICHE / TECHNICAL FEATURES

LIBRERIA MIKAI

Ripiani: realizzati in lamiera di acciaio decapato spessore 15/10 pressopiegata di prima scelta tipo DC01 UNI EN 10130, sono regolabili con un passo di cm 6,5. Massimo di nr 8 ripiani per ogni modulo

Mbox la libreria può accogliere il mobile contenitore Mbox nella sola larghezza di cm 46.

Montanti e traversi: in tubolare di acciaio decapato prodotti secondo la norma EN10305-5/5, a sezione quadra cm 25x25x1.5. Dotata di piedini regolabili. Metallo verniciato con polveri elettrostatiche di resine epossipoliestere.

Piano scrivania home office: in particelle di legno Classe E1 di contenuto Formaldeide, nobilitato melaminico spessore mm 18 e bordato perimetralmente con bordo ABS in tinta con la superficie.

MIKAI BOOKSHELF

Shelves: made of pickled steel foil, press-formed 15/10 thickness, first grade steel sheet DC01 UNI EN 10130, adjustable with a slot of 6,5 cm. Max. of 8 shelves for each module

Mbox: the library can accommodate the Mbox storage unit in the width of cm 46 only.

Uprights and crosspieces: made of tubular pickled steel produced according to EN 10305-5 / 5 norm, square section mm 25x25x1.5, equipped with adjustable feet. Metal coated with electrostatic powder epoxy resins.

Home office desktop: in Class E1 Formaldehyde content wood particleboard, veneered with mm 18thick melamine and perimetally trimmed with ABS edge matching the surface.

MBox



MBox, un mobile contenitore dalle dimensioni contenute, incarna l'eccellenza nella versatilità e nella funzionalità. Progettato per adattarsi con facilità a vari contesti, come casa e ufficio, questo mobile offre un'ampia gamma di configurazioni che si adattano alle tue esigenze di storage.

La sua flessibilità si manifesta nella possibilità di utilizzare il MBox aperto o chiuso, offrendo una varietà di opzioni di presentazione. La scelta tra un'anta metallica o in fibra legnosa consente di personalizzare l'estetica del mobile, aggiungendo stile e carattere al tuo spazio. L'interno di MBox offre ulteriori opportunità di personalizzazione, consentendo l'aggiunta di uno o più cassetti realizzati in metallo o fibra legnosa. Questa caratteristica ottimizza lo spazio interno, permettendoti di organizzare gli oggetti in modo efficiente e personalizzato.

La flessibilità di posizionamento del MBox è una sua caratteristica distintiva. Può essere montato con facilità sul muro, offrendo una soluzione sospesa che massimizza lo spazio a pavimento. Alternativamente, l'opzione di ruote rende il MBox facilmente trasportabile, mentre i piedini assicurano stabilità su varie superfici.

Il MBox è disponibile in una vasta gamma di colori per adattarsi a qualsiasi stile d'arredamento. Sono disponibili 9 colori di metallo e 9 colori di legno, permettendoti di personalizzare ulteriormente il mobile in base al proprio gusto e alle tonalità presenti nell'ambiente circostante.

***MBox**, a compact-sized storage unit, embodies excellence in versatility and functionality. Designed to effortlessly adapt to various environments, such as homes and offices, this storage unit offers a wide range of configurations to meet your storage needs.*



Its flexibility is evident in the option to use MBox open or closed, providing a variety of presentation choices. The choice between a metal or wood fiber door allows you to personalize the aesthetics of the unit, adding style and character to your space.

The interior of MBox provides additional customization opportunities, allowing the addition of one or more drawers made of metal or wood fiber. This feature optimizes internal space, enabling you to organize items efficiently and in a personalized manner.

The distinctive feature of MBox is its flexibility in positioning. It can be easily wall-mounted, offering a suspended solution that maximizes floor space. Alternatively, the option of wheels makes MBox easily transportable, while the feet ensure stability on various surfaces.

MBox is available in a wide range of colors to suit any interior style. With 9 metal colors and 9 wood colors, is possible to customize the unit to match the preferences and the tones in the surrounding environment.

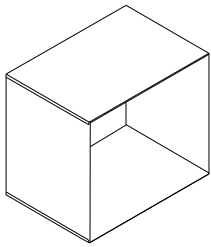

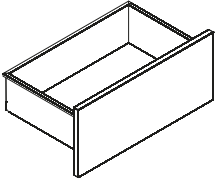
MBOX																																				
DESCRIZIONE <i>description</i>	CODICE <i>code</i>	KG	M ³	COLLI <i>pcs</i>		CODICE FINITURA (*) <i>finish code (*)</i>																														
MBOX CONTENITORE cm L 46 x P 32 x H 40 <i>Mbox cabinet cm W 46 x D 32 x H 40</i> 	MBOXCONT****	10,50	0,075	1,00																																
MBOX MENSOLA PER CONTENITORE cm L 44.3 x P 30 <i>Mbox cabinet shelf cm W 44.3 x D 30</i> 	MBOXRIPI****	0,80	0,018	1,00																																
MBOX CASSETTO METALLICO <i>Mbox metal drawer</i>  involucro cassetto sempre nero <i>drawer casing only black</i>	MBOXCAFE****	3,50	0,026	1,00																																
						COLORI METALLO / METAL COLORS																														
						<table border="1"> <thead> <tr> <th>(*)</th> <th>colore</th> <th>colour</th> </tr> </thead> <tbody> <tr> <td>4002</td> <td>bianco</td> <td>white</td> </tr> <tr> <td>5000</td> <td>nero matt</td> <td>matt black</td> </tr> <tr> <td>2008</td> <td>avio</td> <td>misty blue</td> </tr> <tr> <td>3900</td> <td>rosso granata</td> <td>granata red</td> </tr> <tr> <td>2006</td> <td>verde salvia</td> <td>sage green</td> </tr> <tr> <td>2004</td> <td>cipria</td> <td>dusty pink</td> </tr> <tr> <td>2003</td> <td>caffè</td> <td>coffee</td> </tr> <tr> <td>7016</td> <td>antracite</td> <td>anthracite</td> </tr> <tr> <td>7035</td> <td>grigio</td> <td>light grey</td> </tr> </tbody> </table>	(*)	colore	colour	4002	bianco	white	5000	nero matt	matt black	2008	avio	misty blue	3900	rosso granata	granata red	2006	verde salvia	sage green	2004	cipria	dusty pink	2003	caffè	coffee	7016	antracite	anthracite	7035	grigio	light grey
(*)	colore	colour																																		
4002	bianco	white																																		
5000	nero matt	matt black																																		
2008	avio	misty blue																																		
3900	rosso granata	granata red																																		
2006	verde salvia	sage green																																		
2004	cipria	dusty pink																																		
2003	caffè	coffee																																		
7016	antracite	anthracite																																		
7035	grigio	light grey																																		

MBOX

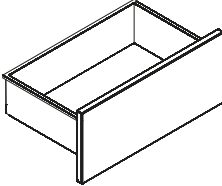
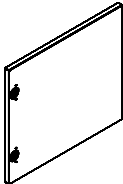
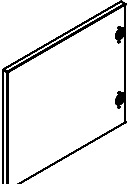
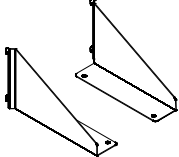
DESCRIZIONE <i>description</i>	CODICE <i>code</i>	KG	M ³	COLLI <i>pcs</i>		CODICE FINITURA (*) <i>finish code (*)</i>																														
MBOX DRAWER CON FRONTALE IN LEGNO <i>Mbox drawer with wooden front</i>  involucro cassetto solo nero <i>drawer casing only black</i>						LEGNO / WOOD <table border="1"> <thead> <tr> <th>(*)</th> <th>colore</th> <th>colour</th> </tr> </thead> <tbody> <tr><td>0041</td><td>avio</td><td>misty blue</td></tr> <tr><td>0059</td><td>nero</td><td>black matt</td></tr> <tr><td>0046</td><td>cipria</td><td>dusty pink</td></tr> <tr><td>0003</td><td>rovere</td><td>oak</td></tr> <tr><td>0040</td><td>verde salvia</td><td>sage green</td></tr> <tr><td>0007</td><td>noce classico</td><td>classic walnut</td></tr> <tr><td>0013</td><td>noce moderno</td><td>modern walnut</td></tr> <tr><td>0068</td><td>bianco</td><td>white</td></tr> <tr><td>0039</td><td>rosso granata</td><td>granata red</td></tr> </tbody> </table>	(*)	colore	colour	0041	avio	misty blue	0059	nero	black matt	0046	cipria	dusty pink	0003	rovere	oak	0040	verde salvia	sage green	0007	noce classico	classic walnut	0013	noce moderno	modern walnut	0068	bianco	white	0039	rosso granata	granata red
	(*)	colore	colour																																	
0041	avio	misty blue																																		
0059	nero	black matt																																		
0046	cipria	dusty pink																																		
0003	rovere	oak																																		
0040	verde salvia	sage green																																		
0007	noce classico	classic walnut																																		
0013	noce moderno	modern walnut																																		
0068	bianco	white																																		
0039	rosso granata	granata red																																		
MBOXCALE****	3,50	0,026	1,00																																	
MBOX PORTA METALLICA cm L45 x H39,5 <i>Mbox steel door dimensioni cm W45 x H39,5</i>  involucro cassetto sempre nero						COLORI METALLO / METAL COLORS <table border="1"> <thead> <tr> <th>(*)</th> <th>colore</th> <th>colour</th> </tr> </thead> <tbody> <tr><td>4002</td><td>bianco</td><td>white</td></tr> <tr><td>5000</td><td>nero matt</td><td>matt black</td></tr> <tr><td>2008</td><td>avio</td><td>misty blue</td></tr> <tr><td>3900</td><td>rosso granata</td><td>granata red</td></tr> <tr><td>2006</td><td>verde salvia</td><td>sage green</td></tr> <tr><td>2004</td><td>cipria</td><td>dust pink</td></tr> <tr><td>2003</td><td>caffè</td><td>coffee</td></tr> <tr><td>7016</td><td>antracite</td><td>anthracite</td></tr> <tr><td>7035</td><td>grigio</td><td>light grey</td></tr> </tbody> </table>	(*)	colore	colour	4002	bianco	white	5000	nero matt	matt black	2008	avio	misty blue	3900	rosso granata	granata red	2006	verde salvia	sage green	2004	cipria	dust pink	2003	caffè	coffee	7016	antracite	anthracite	7035	grigio	light grey
	(*)	colore	colour																																	
4002	bianco	white																																		
5000	nero matt	matt black																																		
2008	avio	misty blue																																		
3900	rosso granata	granata red																																		
2006	verde salvia	sage green																																		
2004	cipria	dust pink																																		
2003	caffè	coffee																																		
7016	antracite	anthracite																																		
7035	grigio	light grey																																		
MBOXANTF****	1,80	0,008	1,00																																	
MBOX PORTA IN LEGNO cm L45 x H39,5 <i>Mbox wooden door cm W45 x H39,5</i>  involucro cassetto sempre nero						LEGNO / WOOD <table border="1"> <thead> <tr> <th>(*)</th> <th>colore</th> <th>colour</th> </tr> </thead> <tbody> <tr><td>0041</td><td>avio</td><td>misty blue</td></tr> <tr><td>0059</td><td>nero</td><td>black matt</td></tr> <tr><td>0046</td><td>cipria</td><td>dusty pink</td></tr> <tr><td>0003</td><td>rovere</td><td>oak</td></tr> <tr><td>0040</td><td>verde salvia</td><td>sage green</td></tr> <tr><td>0007</td><td>noce classico</td><td>classic walnut</td></tr> <tr><td>0013</td><td>noce moderno</td><td>modern walnut</td></tr> <tr><td>0068</td><td>bianco</td><td>white</td></tr> <tr><td>0039</td><td>rosso granata</td><td>granata red</td></tr> </tbody> </table>	(*)	colore	colour	0041	avio	misty blue	0059	nero	black matt	0046	cipria	dusty pink	0003	rovere	oak	0040	verde salvia	sage green	0007	noce classico	classic walnut	0013	noce moderno	modern walnut	0068	bianco	white	0039	rosso granata	granata red
	(*)	colore	colour																																	
0041	avio	misty blue																																		
0059	nero	black matt																																		
0046	cipria	dusty pink																																		
0003	rovere	oak																																		
0040	verde salvia	sage green																																		
0007	noce classico	classic walnut																																		
0013	noce moderno	modern walnut																																		
0068	bianco	white																																		
0039	rosso granata	granata red																																		
MBOXANTL****	1,80	0,008	1,00																																	
SET 2 STAFFE PER IL MONTAGGIO DEL CONTENITORE MBOX E DEL MIKAI DESKTOP SU LIBRERIA MIKAI <i>Set of 2 brackets to mount Mbox container and Mikai Desktop on Mikai bookcase</i> 						COLORI METALLO / METAL COLORS <table border="1"> <thead> <tr> <th>(*)</th> <th>colore</th> <th>colour</th> </tr> </thead> <tbody> <tr><td>4002</td><td>bianco</td><td>white</td></tr> <tr><td>5000</td><td>nero matt</td><td>matt black</td></tr> <tr><td>2008</td><td>avio</td><td>misty blue</td></tr> <tr><td>3900</td><td>rosso granata</td><td>granata red</td></tr> <tr><td>2006</td><td>verde salvia</td><td>sage green</td></tr> <tr><td>2004</td><td>cipria</td><td>dusty pink</td></tr> <tr><td>2003</td><td>caffè</td><td>coffee</td></tr> <tr><td>7016</td><td>antracite</td><td>anthracite</td></tr> <tr><td>7035</td><td>grigio</td><td>light grey</td></tr> </tbody> </table>	(*)	colore	colour	4002	bianco	white	5000	nero matt	matt black	2008	avio	misty blue	3900	rosso granata	granata red	2006	verde salvia	sage green	2004	cipria	dusty pink	2003	caffè	coffee	7016	antracite	anthracite	7035	grigio	light grey
	(*)	colore	colour																																	
4002	bianco	white																																		
5000	nero matt	matt black																																		
2008	avio	misty blue																																		
3900	rosso granata	granata red																																		
2006	verde salvia	sage green																																		
2004	cipria	dusty pink																																		
2003	caffè	coffee																																		
7016	antracite	anthracite																																		
7035	grigio	light grey																																		
MBOXKITS****	1,50	0,025	1,00																																	

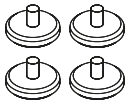
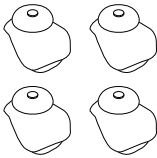
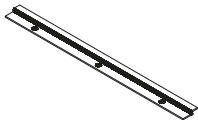
MBOX								
DESCRIZIONE <i>description</i>	CODICE <i>code</i>	KG	M ³	COLLI <i>pcs</i>		CODICE FINITURA (*) <i>finish code (*)</i>		
MBOX SET DI 4 PIEDINI PER L'APPOGGIO DEL CONTENITORE MBOX A TERRA <i>Mbox set of 4 supporting feet to use mbox on the floor</i> 	MBOXKIT4****	0,20	0,002	1,00				
						COLORE / COLOR		
						(*)	colore	colour
						PI99 Nero Black		
MBOX SET DI 4 RUOTE PER L'APPOGGIO DEL CONTENITORE MBOX A TERRA <i>Mbox set of 4 supporting castors to use mbox on the floor</i> 	MBOXKIT4****	0,20	0,002	1,00				
						COLORE / COLOR		
						(*)	colore	colour
						RU99 Nero Black		
MBOX STAFFE PER IL MONTAGGIO DI 1 O 2 O 3 CONTENITORI MONTATI IN LINEA <i>Bracket for linear wall mounting of 1 or 2 or 3 Mbox</i> 	MBOXMU1B****	0,30	0,002	1,00				
	COLORE / COLOR							
	(*)	colore	colour					
							0100 Zinco Zinc	
	MBOXMU2B****	0,60	0,002	1,00				
	MBOXMU3B****	0,90	0,002	1,00				

■ Montaggio MBOX a muro
Wall mounted MBOX

MBOX MU1B

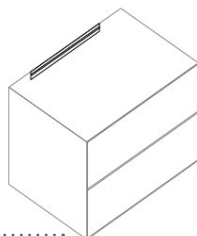

MBOX MU2B

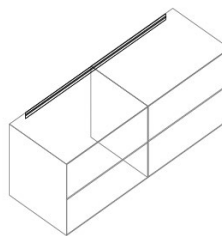

MBOX MU3B

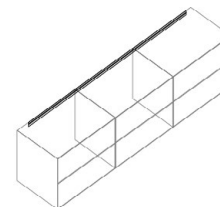

DESCRIZIONI TECNICHE / TECHNICAL FEATURES

■ MBOX

Anta in acciaio: in lamiera di acciaio decapato spessore 8/10 pressopiegata di prima scelta tipo DC01 UNI EN 10130.

Anta in legno: in particelle di legno Classe E1 di contenuto Formaldeide, nobilitato melaminico spessore mm 18 e bordato perimetralmente con bordo ABS sp. mm 2 in tinta con la superficie. Apertura con sistema push and pull fornito a corredo.

Cassetto estraibile con frontale metallico: in lamiera di acciaio decapato spessore 8/10 pressopiegata di prima scelta tipo DC01 UNI EN 10130. Cassetto in metallo con frontale in legno: in particelle di legno Classe E1 di contenuto Formaldeide, nobilitato melaminico spessore mm 18 e bordato perimetralmente con bordo ABS sp. mm 2 in tinta con la superficie. Guide con apertura con sistema push and pull.

Ripiano in acciaio: in lamiera di acciaio decapato spessore 8/10 pressopiegata di prima scelta tipo DC01 UNI EN 10130.

Staffe per fissaggio a libreria Mikai: in lamiera di acciaio decapato spessore 15/10 pressopiegata di prima scelta tipo DC01 UNI EN 10130.

Metallo verniciato con polveri elettrostatiche di resine epossipoliestere.
Staffe per fissaggio a muro: in lamiera di acciaio zincata spessore 15/10 pressopiegata di prima scelta tipo UNI EN 10142.

Piedini livellatori: in materiale plastico, con perno filettato M8;

Kit Ruote sferiche in gomma con supporto rotante.

MBOX

Steel door: made of pickled steel foil, press-formed 8/10 thickness, first grade steel sheet DC01 UNI EN 10130.

Wooden door: in Class E1 Formaldehyde content wood particleboard, veneered with mm 18 thick melamine and perimetally trimmed with mm 2 thick ABS edge matching the surface. Provided with push and pull opening system.

Extractable drawer with metal front: made of pickled steel sheet, press-formed 8/10 thickness, first grade steel sheet DC01 UNI EN 10130. Metal drawer with wooden front: in Class E1 Formaldehyde content wood particleboard, veneered with mm 18 thick melamine and perimetally trimmed with mm 2 thick ABS edge matching the surface. Drawer guides with push and pull opening system.

Steel shelf: pickled steel sheet 8/10 thickness, press-formed first grade DC01 UNI EN 10130.

Fixing brackets for Mikai bookcase: made of pickled sheet steel, press-formed 8/10 thickness, first grade steel sheet DC01 UNI EN 10130.

Metal coating with electrostatic powder epoxy resins.

Brackets for wall mounting: made of galvanized steel sheet with a thickness of 15/10 press-formed, first grade steel sheet UNI EN 10142

Leveling feet: made of plastic material, with M8 threaded pin.

Castors: Rubber spherical castors kit with rotating support.

CARTELLA COLORI METALLI

metal sample color

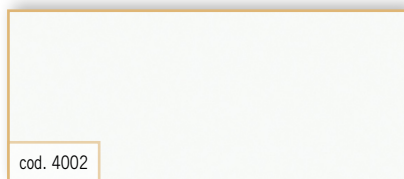

cod. 4002

bianco *white*
RAL 9003

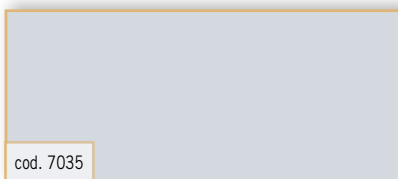

cod. 7035

grigio *grey*
RAL 7035

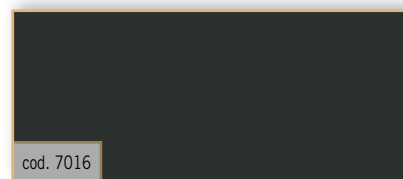

cod. 7016

antracite *anthracite*
RAL 7016

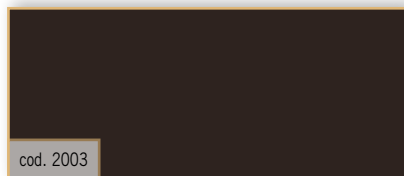

cod. 2003

caffè finitura soft touch *coffee texture soft touch*
RAL 8019

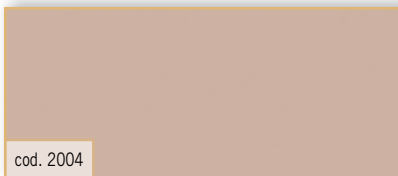

cod. 2004

cipria *dust pink*
#C7AD9D

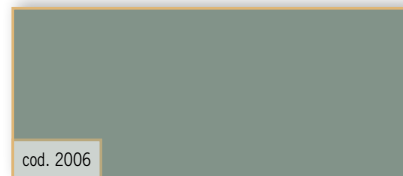

cod. 2006

verde salvia *sage green*
#868B81



cod. 3900

rosso granata *granata red*
RAL 3005



cod. 2008

avio *misty blue*
RAL 5014

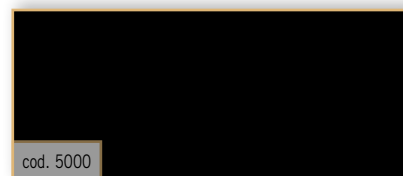

cod. 5000

nero matt *matt black*
RAL 9011

■ Altri colori RAL sono disponibili su richiesta con un sovrapprezzo del 10%
Other RAL colors are available on demand with 10% overprice

I codici colori dei metalli corrispondono alle codifiche RAL standard internazionali
The color codes of our metal match with International Standard RAL

CARTELLA COLORI LEGNO

wood sample color



cod. 0003

rovere oak



cod. 0007

noce classico classic walnut



cod. 0013

noce moderno modern walnut



cod. 0039

rosso granata granata red

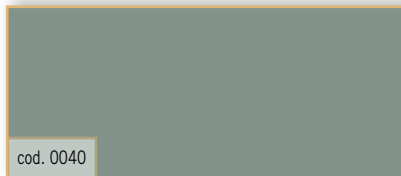

cod. 0040

verde salvia sage green

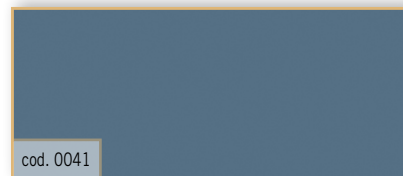

cod. 0041

avio misty blue

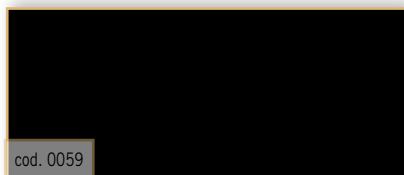

cod. 0059

nero matt matt black



cod. 0046

cipria dusty pink

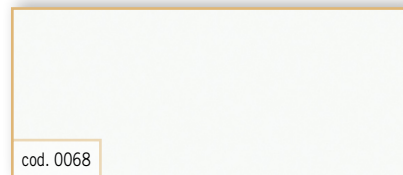

cod. 0068

bianco white

■ GARANZIA

Tutti mobili metallici, cassettiere, classificatori, armadi spogliatoio, scaffalature, accessori (qui di seguito indicati come arredi metallici) - Tutto il programma di pannelli acustici ZEN (qui di seguito indicato come pannelli ZEN) sono garantiti all'acquirente originale al momento dell'acquisto per un periodo di 2 (due) anni di "servizio a turno unico", la STEELBOX garantisce all'acquirente originale che sia gli arredi metallici che il programma ZEN e tutte le sue parti e componenti sono senza difetti nel materiale e nella lavorazione.

"Difetti" in questa garanzia indica qualsiasi imperfezione che compromette l'utilizzo del prodotto.

La garanzia della STEELBOX è espressamente limitata alla sostituzione di parti e componenti degli arredi metallici e dei pannelli Zen. La garanzia è valida per normali condizioni d'uso indoor. Gli arredi metallici STEELBOX e i pannelli Zen non possono essere utilizzati all'aperto né possono essere messi a contatto con fonti di calore ed umidità a meno che diversamente indicato. Gli arredi metallici, dove indicato, possono essere utilizzati all'esterno, tuttavia, collocati sotto una copertura al riparo dall'esposizione diretta agli agenti atmosferici. Si consiglia di pulire regolarmente le superfici con prodotti specifici per il trattamento del metallo. I prodotti non sono soggetti a sostituzioni in caso di danni causati da depositi di acqua non prontamente asciugati e rispondenti alle norme indicate nella garanzia nella sezione "la garanzia non copre".

Le parti in vetro devono essere maneggiate con cautela e gli sportelli e cassetti devono essere riportati allo stato di chiusura subito dopo l'uso.

La garanzia non copre:

- 1) difetti causati da un assemblaggio o smontaggio
- 2) uso improprio;
- 3) difetti venuti fuori dopo l'acquisto dovuti a modifiche apportate al prodotto o sue parti, danni intenzionali, incidenti, uso errato, abuso, negligenza, esposizione agli elementi;
- 4) costi di lavoro e montaggio, difetti causati dal trasporto;
- 5) l'uniformità del colore, venatura o tessitura dei materiali di copertura ad eccezione degli standard commercialmente accettabili.

Esclusioni: sono espressamente esclusi dalla garanzia sistemi illuminanti e qualsiasi altro accessorio non prodotto da Metalway s.r.l. Il consumatore, pertanto, in caso di difetti di tali apparecchi o danni causati da tali apparecchi dovrà rivolgersi direttamente al relativo produttore, in base alle condizioni di garanzia previste per tali apparecchi dal produttore.

Il concessionario provvederà a predisporre clausole di garanzia da consegnare all'acquirente finale.

Egli potrà ampliare le garanzie offerte dal Fabbrikante, ma tutte le garanzie aggiuntive saranno a carico del Concessionario stesso.

Nel certificato di garanzia il Concessionario dovrà prevedere, fra l'altro, le modalità mediante le quali l'utente finale dovrà attivare l'intervento in garanzia.

Il Concessionario effettuerà l'intervento in garanzia presso l'utente finale, anche se a carico di STEELBOX, che provvederà al rimborso ovvero ad inviare ai Concessionari le parti da sostituire (se i difetti sono coperti dalla garanzia di STEELBOX).

Il certificato di garanzia predisposto dal Concessionario per gli utenti finali impegna STEELBOX nei limiti del prezzo di acquisto corrisposto dal Concessionario.

Il rispetto delle leggi vigenti nel Territorio, per quanto concerne la compilazione del certificato di garanzia, è a cura e carico del Concessionario.

■ WARRANTY

All metal furniture, including cabinets, filing cabinets, locker cabinets, shelving units, accessories (hereinafter referred to as metal furniture) - The entire ZEN acoustic panel program (hereinafter referred to as ZEN panels) are guaranteed to the original purchaser at the time of purchase for a period of 2 (two) years of "single-shift service", STEELBOX guarantees to the original purchaser that both the metal furniture and the ZEN program and all its parts and components are free from defects in material and workmanship.

"Defects" in this warranty indicate any imperfection that compromises the use of the product.

STEELBOX's warranty is expressly limited to the replacement of parts and components of metal furniture and ZEN panels. The warranty is valid for normal indoor use conditions. STEELBOX metal furniture and ZEN panels cannot be used outdoors or in contact with heat and moisture sources unless otherwise indicated.

Metal furniture, where indicated, can be used outdoors; however, they should be placed under a covering protected from direct exposure to weather elements. It is recommended to clean the surfaces with specific metal treatment products regularly. Products are not subject to replacement in case of damage caused by water deposits not promptly dried and compliant with the standards indicated in the warranty in the "warranty does not cover" section.

Glass parts must be handled with care, and doors and drawers must be closed immediately after use.

The warranty does not cover:

- 1) Defects caused by assembly or disassembly.*
- 2) Improper use.*
- 3) Defects arising after purchase due to modifications made to the product or its parts, intentional damage, accidents, misuse, abuse, negligence, exposure to the elements.*
- 4) Labor and assembly costs, defects caused by transportation.*
- 5) Uniformity of color, grain, or texture of covering materials except for commercially acceptable standards.*

Exclusions: lighting systems and any other accessories not produced by Metalway s.r.l. are expressly excluded from the warranty. The consumer, therefore, in the event of defects in such appliances or damage caused by such appliances, will have to contact the relevant manufacturer directly, based on the warranty conditions provided for such appliances by the manufacturer.

The dealer will arrange warranty clauses to be delivered to the end customer. They may extend the warranties offered by the manufacturer, but all additional warranties will be the responsibility of the dealer.

In the warranty certificate, the dealer must provide, among other things, the procedures by which the end user must activate the warranty intervention. The dealer will carry out the warranty intervention at the end user's location, even if at STEELBOX's expense, which will reimburse or send the dealers the parts to be replaced (if the defects are covered by STEELBOX's warranty).

The warranty certificate prepared by the dealer for end users binds STEELBOX within the limits of the purchase price paid by the dealer. Compliance with the laws in force in the Territory, regarding the completion of the warranty certificate, is the responsibility of the dealer.

I colori riportati nel catalogo sono indicativi,
per le finiture reali fare riferimento ai codici
RAL indicati nel listino prezzi

*The colors shown in the catalog are
indicative. For the actual finishes, refer to
the RAL codes indicated in the price list.*

L'azienda si impegna a migliorare i propri
prodotti per soddisfare le esigenze di un
mercato in continua evoluzione.

A tale scopo ci riserviamo il diritto di
apportare le necessarie migliorie e modifiche
ai prodotti senza preavviso.

La Direzione

Metalway srl is engaged to improve its
products to satisfy the needs of an evolving
market. For this reason all necessary
improvements as far as modifications can
be carried on without prior notice.

The Management

ENGINEERING

R&D Metalway srl

DESIGNER

Roberto Molteni: Zen, Mikai, Mbox,
Kaffeina, Tuck, Hawk, Suite tables&sofa,
Jet System, York, Loop, Sofa suite, Suite
Desks

Barbara Pollini: Clara

Officina di Architettura: My Flower

R&D Metalway: Kyoto, Snap, B-Cat,

Umbrella, Bin, D-Utility, Storage, String,

Mix, Tepee, Simplex collection

RENDERING

Matic® Animation

GRAPHIC PROJECT:

Dam.co | Creativi Digitali

Marketing & Concept

Forwell Marketing USA

Marketing Department Metalway

Powered by:



cod. 002 - 05.2024

Steelbox
division of Metalway s.r.l.

Via dell'Industria 10
64018 Tortoreto
Teramo (Italy)

Tel. +39 0861 1994208

Fax +39 0861 1994382

www.steelbox.it
info@steelbox.it

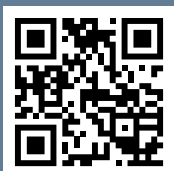

Powered by:

